

Critical Components' Selection Methodology of a Microgripper for Intracorporeal Surgery

Liseth Pasaguayo^{1,2}, Zeina Al Masry¹, Sergio Lescano², and Nouredine Zerhouni¹

¹ FEMTO-ST institute, Univ. Bourgogne Franche-Comté, Besançon, Bourgogne-Franche-Comté, 25000, France

lisethpasaguayoec@ieee.org

zeina.al.masry@ens2m.fr

nouredine.zerhouni@femto-st.fr

² AMAROB Technologies, Besançon, Bourgogne-Franche-Comté, 25000, France

sergio.lescano@amarob.com

ABSTRACT

Prognostics and Health Management (PHM) is widely used to study the health state of the system. However, the application of PHM for micro medical devices is a big challenge since they are made up of multiple components which are complex. Prognostics approaches for complex microsystems should be oriented towards identifying critical components and monitoring them individually. This implies the importance of identifying as much as possible the components that can lead to system failures.

This work proposes a methodology to select critical components of a micro medical device for PHM implementation. The micro device is a microgripper composed of four components and four steel wires of 0.08 mm in diameter. A risk analysis is performed according to the requirements of ISO standard 14971 for medical devices. This standard provides some techniques that allow to identify some failures modes which affect the behavior and performance of the final product. This work can be seen as a necessary preliminary step before data collection and PHM implementation for such tiny devices. For that purpose, the Failure mode and effect analysis (FMEA) technique is used in order to select critical components. The selection of the critical components is based on a criticality analysis (CA) mainly to prioritize and minimize the effects of critical failure modes that can lead to fault propagation. In addition, some practical guides are presented for PHM development in future works.

NOMENCLATURE

<i>PHM</i>	Prognostics and Health Management
<i>RUL</i>	Remaining useful life
<i>FMEA</i>	Failure mode and effects analysis
<i>CA</i>	Criticality analysis
<i>FMECA</i>	Failure mode, effect and criticality analysis
<i>FDA</i>	Food and Drug Administration
<i>MDR</i>	Medical Devices Regulation
<i>HAZOP</i>	Hazard and Operability Study
<i>FTA</i>	Fault Tree Analysis
<i>MAUDE</i>	Manufactures and Users Facility Device Experience
<i>LVM</i>	Low carbon Vacuum melt
<i>MIS</i>	Minimally invasive surgery
<i>D – FMEA</i>	Design-Failure mode and effects analysis
<i>P – FMEA</i>	Process-Failure mode and effects analysis
<i>A – FMEA</i>	Analysis-Failure mode and effects analysis
<i>S – FMEA</i>	Service-Failure mode and effects analysis
<i>S</i>	Severity
<i>O</i>	Occurrence
<i>D</i>	Detection
<i>RPN</i>	Risk priority number
<i>FEA</i>	Finite element analysis

1. INTRODUCTION

The development of microscale medical devices has had great growth in recent years in a variety of medical applications. However, the development of microscale medical devices brings with it some challenges due to their small sizes, the number of components, the used materials, and the manufacturing processes. Some of these medical devices are intended to be used inside the human body in contact with mucous membranes, blood, tissues, and bones. Therefore, they must be safe and reliable in order to guarantee a good performance during their operating time. The probability of failure in med-

Liseth Pasaguayo et al. This is an open-access article distributed under the terms of the Creative Commons Attribution 3.0 United States License, which permits unrestricted use, distribution, and reproduction in any medium, provided the original author and source are credited.

ical devices could represent different risks for the patient. The medical device manufacturers must offer the highest level of reliability in the phases of design, manufacturing, assembly, and production in order to reduce as much as possible the failure during a surgical procedure.

Well-made designs provide safer products. In (Dyadem, 2003), the author mentioned that approximately 76% of all engineering changes are due to the correction of bad designs. In this way, in order to prevent failures on the product and reduce any kind of hazard, the identification of design defects or potential failure sources is an important consideration before proceeding to the next stages of a product.

The Prognostics and Health Management (PHM) is an approach that integrates different technologies and techniques. These allow detecting anomalies or failures, evaluating the current status, monitoring the system, and estimating the remaining useful life (RUL) of an equipment (Brahimi, Medjaher, Leouatni, & Zerhouni, 2016) through knowledge of its physics, information, or data (Zio, 2022). One way to analyze the systems is by supervising the behavior of their critical components according to (Mosallam, Medjaher, & Zerhouni, 2015) and (Brahimi et al., 2016). For this reason, critical components' identification and selection is the main and first step to PHM implementation, since these can affect the performance of the system in terms of safety and reliability.

There are some regulations and standards for medical devices that provide a combination of techniques to assess the reliability of the devices. The main regulations are the Food and Drug Administration (FDA) in the United States and the Medical Devices Regulation (MDR) in Europe, which provide information to guarantee high reliability in all phases of the design and development of the product. These regulations are supported by the International Organization for Standardization [ISO], being the ISO 14971 destined to risk management of medical devices. These standard provides some qualitative and quantitative risk analysis techniques such as Failure Mode and Effects Analysis (FMEA), Hazard and Operability Study (HAZOP) and Fault Tree Analysis (FTA). According to (ISO, 2019) these three techniques are the most used for medical devices. FMEA technique is currently one of the most used for failure analysis in risk management in medical devices design, according to (Onofrio, Piccagli, & Segato, 2015) and (Fechter & Barba, 2004).

Therefore, this work aims to provide a methodology for critical components' selection for a microgripper destined to work inside the human body. This methodology will allow the PHM development in the design phase for similar micro medical devices, in order to guarantee a safe and marketable device. In addition, considering the challenges of PHM implementation at the microscale, a detailed FMEA is developed which helps to identify the critical components from design stage.

The remainder of this paper is organized in the following sections. Section 2 explains the main PHM challenges to implement in micro medical devices. Section 3 describes the components of the microgripper to be studied. Section 4 explains the proposed methodology to select the critical components. In Section 5 all the results are presented according to the proposed methodology, and finally, Section 6 is to conclude our work.

2. MEDICAL MICRODEVICES AND ITS CHALLENGES FOR PHM IMPLEMENTATION

The PHM context involves different disciplines such as mathematics, statistics, computer science, physics and engineering (Zio, 2022). It allows to evaluate the health state of a system starting from data acquisition, data manipulation, health assessment, diagnostics, prognostics and decision support (Brahimi et al., 2016).

Although PHM systems have been implemented for years in industry, today their use continues to expand in areas such as microelectronics, micromechanics, and micromechatronics. However, up to our knowledge, PHM implementation for micro medical devices has not been much studied in the literature. This may be due to the challenges that those bring with them in terms of design, size, the number of constitutive components, materials used, manufacturing, assembly processes, and intended use. Developing a PHM for micro medical device depends mainly on physics, data availability, and data collection. (1) The physics is related to the complexity and the number of components. When devices have many components, it is sometimes difficult to identify the component that is degrading as well as the cause of the degradation. (2) The data availability is a challenging part here since there is no existing databases that provide information on the behavior and performance of similar micro medical devices. The only available information is the number of possible failure modes of micro medical devices that are reported by the FDA and Manufactures and Users Facility Device Experience (MAUDE). However, these failure modes can be considered as a guide to identify failures in similar devices (Onofrio et al., 2015). (3) The data collection is related to the complexity and size of the microsystem and the number of components. This may lead to the implementation of internal or external sensors. Nevertheless, the complexity of the functions of the sensors should be deeply studied in order to guarantee a representative data of the degradation phenomenon. The data collection step is crucial for a successful PHM implementation.

3. MICROGRIPPER DESCRIPTION

The microgripper presented in this work is designed to be used in intracorporeal surgeries. An example of its use is shown in the Figure 1. Its total dimension should be as small

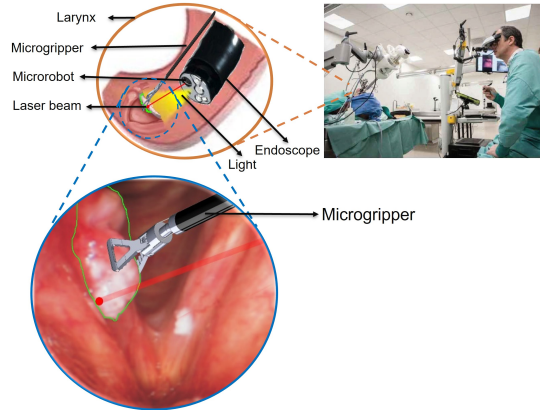

Figure 1. Microgripper operation in larynx surgery.

as possible in order to be used through small incisions that are performed during intracorporeal surgeries, mainly in minimally invasive surgery (MIS).

For instance, the commercial microgrippers developed by Intuitive surgical Inc. da Vinci known as EndoWrist have diameters between 5 and 8.5 mm. Another example is the microgripper of 8 mm in diameter developed by the Olympus Medical System Group (Group, 2022), (Valley, 2018) and FlexDex (Surgical, 2022) to be used in a robotic system. Medical Microinstruments (MMI, 2020) developed a microgripper that has a diameter of 3 mm.

We are focused on diameter size since these microgrippers must be inserted in small tubes or cannulas called trocars to perform incisions of 3 mm, 5 mm, 10 mm, or 12 mm according to the surgical procedure mentioned by (Holcomb, 2010) and (Fernandes & Gracias, 2009). The smallest microgrippers can be used for different types of MIS such as gastroenterological surgery, nerosurgery, cardiac surgery, gynecologic surgery, laparoscopic surgery, and biomedical applications (Fu, Luo, Flewitt, & Milne, 2012).

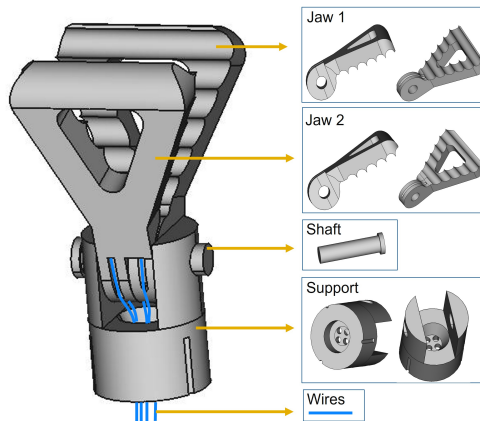

Figure 2. Microgripper constitutive components' description.

Amarob company presents the design of a 2 mm diameter microgripper to be used in intracorporeal surgeries. This microgripper is composed of two jaws, a shaft, a support, and four steel wires shown in Figure 2. These components enable to perform the opening and closing movements of the jaws 1 and 2 in order to hold, spread and pull out some tissues or anomalies during the surgical procedure. This microgripper will be driven by four steel wires of 0.08 mm in diameter, two wires will be used for opening motion and two wires for closing motion through four motors.

Before certifying the Amarob's microgripper for surgical procedures, more studies related to its performance should be done. Recall that the ultimate goal is to implement the PHM in the design of a micro medical device. Before proceeding to the whole implementation, the focus is on identifying the critical components. This allows data characterizing and PHM process development.

4. METHODOLOGY

The methodology proposed for critical components' selection for micro medical devices is shown in Figure 3. It is based on risk assessment according to ISO 14971. The risk assessment must cover two aspects: risk analysis and risk evaluation. Within risk analysis, some factors are established, for example, the phase of the product's life cycle that is to be analyzed, what can go wrong in the systems or components of the system, and mainly to understand the intended use or purpose of the system. For that, the hazards and characteristics related to its safety and reliability must be identified. There are some techniques with qualitative or quantitative approaches that evaluate the safety and reliability of the system. Above all, these techniques enable us to identify failures that occur in micro medical devices that can mean potential harm or injury to patients, (Kiran, 2017). Their use depends on the complexity of the system, and the amount of data or information available from the system (Dyadem, 2003). Then, in order to select the critical components of the system, a safety and reliability technique will be chosen.

4.1. Risk analysis techniques for critical components identifications for PHM

There exist many procedures to implement a PHM system. One of them is to identify the critical components that are the first ones to fail and affect its performance. The qualitative FMEA technique recommended by ISO 14971, is referred to as bottom-up or inductive analysis. This means that the analysis starts at the component level where the possible component failure modes are identified, and then it is examined what the consequences are on a higher level (Elahi, 2018). This technique can be used throughout the life cycle of a product by implementing different types of FMEAs, for example, design FMEA (D-FMEA), process FMEA (P-

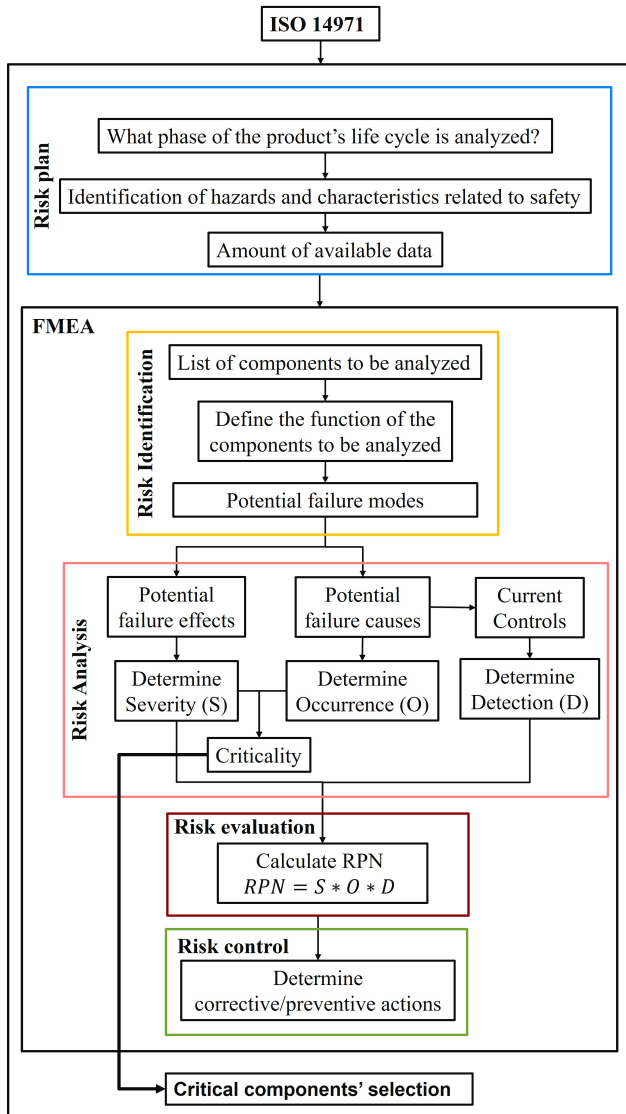

Figure 3. Methodology for critical components' selection

FMEA), application FMEA (A-FMEA), and service FMEA (S -FMEA) (Basu, 2017). In the sequel, D-FMEA will be explained since this work aims to provide the methodology to select the critical components of a system, by analyzing from the early design stage.

4.1.1. Design FMEA

The FMEA steps consist of four steps:

Step 1 - Risk identification. This step includes the listing of the system's components, the definition of the function of each component, and the identification of the potential failure modes of each component. The failure mode is the way the failure occurs and its effect on system operation (Dhillon, 2000), that is, the manner in which the product/process fails to perform the intended function (Basu, 2017).

Step 2 - Risk analysis. In this step the potential causes for each failure mode are determined, the potential effects for each failure mode are identified and the current controls that are intended to eliminate failure causes are defined. Failure causes are the main reasons that lead to a failure in the system. These causes can be design defects, physical or chemical processes, and quality defects (Dhillon, 2000). Moreover, in this part, a severity value is determined to the failure effect, which is the consequence or consequences of a failure mode on the operation, function, or status of a system or equipment. The severity represents the seriousness of the failure and not the mode of the failure and generally, the severity of the effect is given a severity number (S) from 1 (no danger) to 10 (critical) (Kiran, 2017), a failure effect can be caused by one or more failure modes (Ramakrishna, Tian, Wang, Liao, & Teo, 2015). Within the risk analysis, a probability of occurrence of the failure value is also assigned. Generally, the occurrence (O) takes values from 1 for the least frequent to 10 for the most frequent occurrence. Sometimes these values are taken considering the occurrence of failure of similar systems or products. Another value to determine within the risk analysis is the ease of detection. This allows knowing the control mechanisms that detect the potential cause or the subsequent failure mode before the production of the product. The detection (D), generally takes values between 1 and 10. A high detection number indicates that the chances are high that the failure will escape detection (Dhillon, 2000). Below are some definitions.

- Severity is an assessment of the failure effects on the end user, the local area and the next high-level effects (Dyadem, 2003).
- Occurrence is related to the probability of the failure mode and cause. This is expressed in terms of probability of occurrence (Basu, 2017).
- Detection is an assessment of the ability of current design controls to identify any potential failure mode if it does occur (Dyadem, 2003).
- Criticality analysis (CA) is used to prioritize and minimize the effects of critical failure modes in the early design stage, i.e., this analysis help to classify the significance of each potential failure for each component in the system's design based on a failure rate and a severity ranking. Dhillon, (2020) and (Bona, Silvestri, Forcina, & Petrillo, 2017) mentioned that the CA is a relative measure of severity and its occurrence. CA has quantitative and qualitative approaches. The quantitative approach is used when failure rates, failure modes, failure mode ratios, and failure effects probabilities are known, and the qualitative approach is used when no known failure rates and failure modes are available.
- Criticality Matrix. According to the U.S. Army Corps of engineers (Army-GOE, 2006) the criticality matrix is a graphical or visual tool for identifying and comparing

failure modes for all components within a system or subsystem and their probability of occurring with respect to severity. This is a finer method to prioritize criticality, that is, enables customizing the criticality depending on the needs of each company.

- Failure modes, effect and criticality analysis (FMECA) is an extension of FMEA, this is composed of two separate analysis the FMEA and the Criticality Analysis (CA) (Army-GOE, 2006).

Step 3 - Risk evaluation. In this step, the risk priority number (RPN) is computed by multiplying the values of S, O, and D, such as in Eq. 1.

$$RPN = S \times O \times D \quad (1)$$

RPN is the product of the numerical severity, probability, and detection ratings, it is described in FMEA/FMECA on the scale of 0-1000 according to (Basu, 2017). Depending on the value that the RPN takes, this shows the areas of the greatest concentration, therefore the corrective actions must be focused on reducing its value.

Step 4 - Risk control. In this stage, some corrective/preventive actions are determined in order to reduce the criticality of the failure modes according to (Kiran, 2017). The control actions are focused on reducing the severity of the hazard and the probability of occurrence, taking corrective or preventive actions that allow the risk to be monitored throughout the life of the product.

4.2. Critical components' selection and monitoring in PHM

Critical components of a micro medical device represent risks that can affect severely the health of the patient during a determined function. The main cause of risks depends on the criticality of each failure mode of its components. The failure modes must be reduced as far as possible from the design stage to guarantee a reliable device.

To ensure that the product meets the design specifications, these are subjected to finite element analysis (FEA). However, the FEA for complex systems does not provide reliable results, or in many cases, it is impossible to analyze the entire function of the systems.

Then, when in the risk control stage it is not possible to determine corrective or preventive actions to reduce the criticality of the failure mode of each component, the system must be monitored through the implementation of sensors (see Figure 4). The use of sensors allows getting representative data of the degradation of each component.

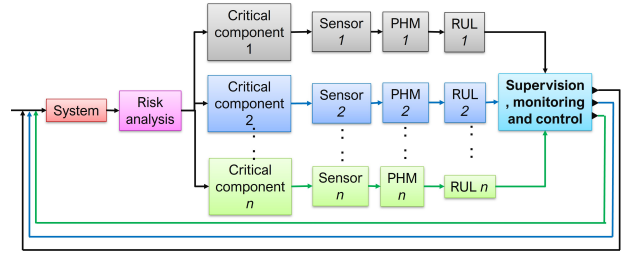

Figure 4. Monitoring of the critical components

5. RESULTS

The methodology described in the previous section is applied to a microgripper that will be used in intracorporeal surgeries. All this study is based on the requirements of ISO 14971. The first step is to identify the phase of the product's life cycle to be analyzed. This work is focused on identifying hazards and failure modes starting from an early stage, for which the design phase is selected.

Mainly, risk assessment must fulfill three specific questions that can affect the safety (Dyadem, 2003):

- What can go wrong?
- How likely is it?
- What are the impacts?

To answer these questions, damages and safety-related characteristics must be identified by answering some questions provided by the ISO standard (Tr, 2020). The Table 1 details the questions that were adapted to the proposed microgripper for intracorporeal surgeries and that help to identify hazards or failure modes.

5.1. First prototype and results of finite element analysis

In this work, the identification of the failure modes is based on some defects that were appreciated in the first prototype. As well as the results of the finite element analysis (FEA) of the microgripper and some information from the literature that reports some failure modes for similar microgripper.

After the manufacture and assembly of the first prototype of the microgripper, some defects were observed in some of its components. For example, some teeth on jaws 1 and 2 broke off. The shaft was fragile during its assembly, which showed that when applying the forces to open and close the jaws, the probability of breaking is very high. Therefore, a redesign was carried out focused on improving the areas where there is a greater stress concentration since they represent one of the causes that lead to failure. Then, the FEA was performed to see if the stress concentration in critical areas was reduced. FEA results were:

- Stress concentration in the last tooth of jaws 1 and 2 as

Questions adopted from ISO 14971	Answers
What is the intended use/purpose, and how is the medical device to be used?	The microgripper will be used for intracorporeal surgeries to operate inside the human body. Either to grasp the tissue or to remove it, thus the microgripper will be driven with steel wires to open and close its jaws.
Is the medical device intended to be in contact with patients or other persons,	The microgripper will be in contact with the patient, mainly with tissues and blood.
What materials and/or components are incorporated in, or are in contact with, the medical device?	The microgripper will be manufactured in stainless steel 316 low carbon vacuum melt (LVM), and this will be the material that will be in contact with tissues and blood.
Is the medical device supplied sterile or intended to be sterilized by the user, or are other microbiological controls applicable?	The device must be sterilized before and after being used.
Is the medical device intended for use in conjunction with other medical devices, medicines or other medical technologies?	The microgripper will be used in conjunction with a microrobot that leads a laser beam.
Does the medical device have a restricted shelf life?	The life of the microgripper will be computed by estimating its RUL by implementing a PHM study.
To what mechanical forces will the medical device be subjected?	The microgripper will be subject to stress, strain, tension and shear forces.
What determines the lifetime of the medical device?	The lifetime of the microgripper depends on the degradation and failure of its components due to cyclic movements during its life cycle and due to the tension in the wires.
Is the medical device intended for single use or multiple uses?	The microgripper has both clamping and expanding functionalities and can be used in different types of minimally invasive surgery, and the number of its uses will be defined by the RUL estimation.
Does installation of the medical device require special training?	The manufacture and assembly process requires special abilities since it is a device at microscale.
Does the medical device have connecting parts or accessories?	The microgripper has a mechanical stage, motorization stage, power supply stage and control stage.
Does the medical device have a control interface?	Yes, it does.
In what ways might the medical device be misused (deliberately or not)?	Incorrect use of the microgripper and exceeding the number of uses established by the manufacturer, as well as operating outside the limit of its useful life.

Table 1. Identification of hazards and characteristics related to safety.

shown in Figure 5 (a) due to the applied force that will allow holding the tissues during the surgical operation.

- The stress concentration in the wire slot, as shown in Figure 5 (b), is due to the force that the motor will exert to pull the wire, which will allow its jaws to open and close. However, this does not represent a problem for the

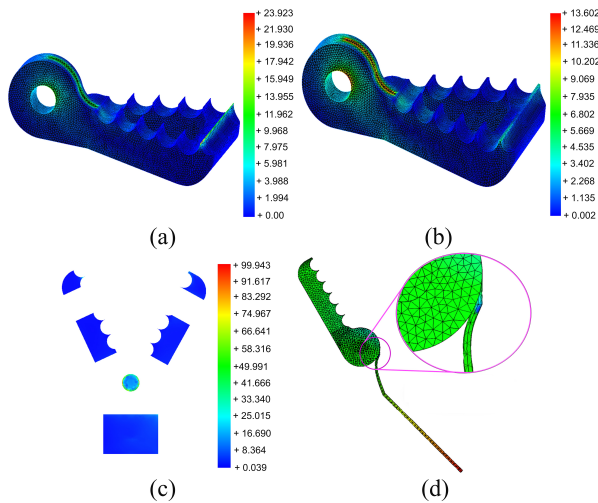

Figure 5. Finite elements' analysis results of microgripper

jaw slot, rather represents a problem for the wire since it shows the pressure that it exerts due to the force exerted by the motor.

- Maximum stress concentration on the shaft, as shown in the cross-section of Figure 5 (c).
- Deformation along the cable is quite significant, as is shown in Figure 5 (d). Moreover, the maximum stress occurs in the joint point between the wire and the slot of the jaw, as shown in view detailed of Figure 5 (d). This gives an idea that the wire will break in a joint o welding point.

5.2. Critical components' selection of the microgripper

The FEA results helped to identify some failure modes for each component of the microgripper as well as their failure causes and failure effects.

The D-FEMEA for each component of the microgripper is detailed in Table 2. The stress concentration in the last tooth of jaws 1 and 2 leads to the failure mode of the jaws, which is the breakage of the tooth in the final product. The potential cause is the small size of the tooth and its effects could reflect directly in the surgical procedure since the precision to hold and pull the tissues would be bad. Then, considering the effect of the failure, a low severity (equal to 5) was

Item.	Function	Potential failure mode	Potential failure effect	S	Potential causes	O	Currents controls	D	RPN	Actions	Response
Jaw 1, Jaw 2	To hold the tissues during the surgery, through the opening and closing movement of the Jaw 1 and Jaw2.	Breakage of the tooth, located at the extreme end of the jaw.	Low precision and difficulty in holding and pulling tissues or abnormalities during the surgical process.	5	The end of the jaw is thin, which makes the tooth tiny as well.	4	Modification in the thin part of the jaw and change of the tooth design.	3	60	Modify the design of the last teeth and leave more material in that area.	The maximum stress concentration in this area was reduced
Support jaw 2	To support jaw 1, and shaft.	No failures modes.	No effects	1	No causes	1	No controls	1	1	No actions	No response
Shaft	To join and support the jaw 1, the jaw 2 and the support. It also supports the force required to open and close the jaws	Breakage of the shaft.	Unavailability of the microgripper.	9	Improper force applied (F1-C1)	6	No controls.	10	540	Implement a control to provide always the same estimated force value	Will be implemented in future work.
				9	Shear force (F1-C2)	9	No controls	10	810	No actions	No response
Wire	Enable to perform the opening and closing movements of the jaw 1 and 2 through a motor force.	Permanent deformation of the shaft	Improper motion of the jaws	8	Improper force applied.	6	No controls.	10	480	Implement a control to provide always the same estimated force value.	Will be implemented in future works.
				10	Repetitive movements of tension of the wire.	9	No controls.	10	900	Carry out tests to obtain the behavior of the wire.	Will be implemented in future work.
Wire	Breakage of the wire.	Difficulty in holding and pulling tissues or abnormalities during the surgical procedure.	Unavailability of the microgripper.	8	Repetitive movements of tension of the wire.	9	No controls.	10	720	Carry out tests to obtain the behavior of the wire.	Will be implemented in future works.
				8	Repetitive movements of tension of the wire.	9	No controls.	10	720	Carry out tests to obtain the behavior of the wire.	Will be implemented in future works.

Table 2. D-FMEA of components of a microgripper

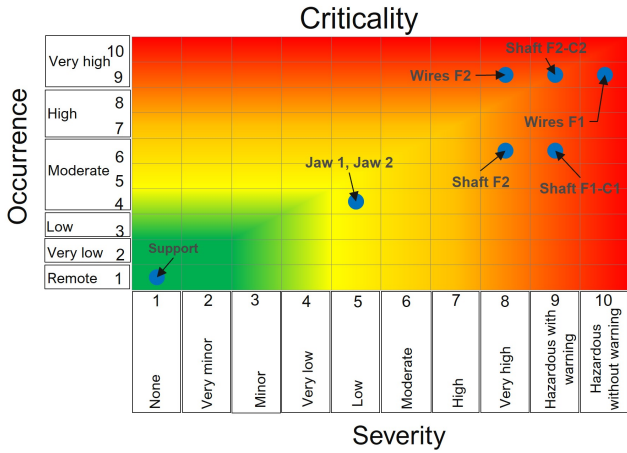

Figure 6. Criticality matrix of the failure modes of the microgripper components.

assigned since the product is operable but with a loss of comfort. The probability of occurrence is moderate (equal to 4) since this could happen if a high force different from the computed force is applied, and the detection is high (equal to 3) since the current controls for prevention are to perform some modification in the design. When performing these changes, the stress concentration in the last tooth was reduced. Then jaw 1 and jaw 2 have a RPN value of 60.

The support was evaluated by FEA but it did not show possible failures nor could any failures be observed in the manufactured component. On the other hand, according to FEA results of the shaft, two failure modes were identified: the breakage of the shaft and the permanent deformation of the shaft. The breakage of the shaft is due to two failure causes, the first one is due to an improper force applied, and the second one is due to the shear force. Both failures lead to the same failure effect which is the unavailability of the microgripper and the severity factor takes a value of 9 (equivalent to hazardous) with a warning. The probability of occurrence of the improper force applied is 6, equivalent to moderate, since this can happen only if there is no external control of the applied force. The detection factor of the improper force takes a value of 10 (equivalent to absolutely impossible) since there are no current controls that can be applied at the design stage to reduce or prevent these failure modes, however, they must be analyzed at later stages. Then the RPN takes a value of 540. As for the shear force, the probability of occurrence is 9 since all the time, when opening and closing motions are performing, the shear will occur in the microgripper. The detection factor is 10 since there are no current controls in this stage to reduce or prevent these failure modes. Then the RPN value takes a value of 810.

The permanent deformation of the shaft is the other failure mode of the shaft. The main failure cause is an improper force

applied that lead to improper motion of the jaws. Then the severity factor is very high (equal to 8) which means even if the component does not fracture, it becomes unavailable. The probability of occurrence and the detection factor take values of 6 and 10 respectively. Then the RPN value is 480. According to FEA results, the wire presents two failure modes, breakage of the wire, and the stretching of the wire. Both are due to the same failure cause, which is repetitive movements of tension. The failure effect leads to the unavailability of the microgripper and the difficulty to hold and pull tissues during the surgical procedure. Then the severity factor takes values of 10 and 8 respectively, the probability of occurrence takes a value of 9 for both failure causes, and the detection factor takes a value of 10 for both cases. The closing movement of the microgripper was simulated in order to analyze the behavior of one wire. For the analysis, a force was placed at the end of the wire and a constraint on the bonded surfaces between the wire and the jaw. This analysis generated a meshing problem preventing the desired resolution. A solution to this problem was to simulate only one jaw, the shaft, and the wire shown in Figure 5 (d), which demonstrates that the deformation along the wire is quite significant. However, this analysis was incomplete, since the friction between the cable and the support could not be simulated. For that reason, the detection factor takes a value of 10 since there are no current controls in this stage to reduce or prevent a failure mode. Then RPN is 900 and 720 respectively.

Although the RPN values show the areas of the greatest concentration to take corrective or preventive actions, in this work the critical elements were selected by performing a criticality analysis to prioritize the critical failure modes of each component considering its probability of occurrence and its seriousness of the failure effect that is the severity. In the criticality matrix shown in Figure 6 the support and the two jaws are in the safe zone that was considered by Amarob company. On the other hand, the shaft and the wire are in the zone of maximum risk. The shaft presents two failure modes that are detailed in Table 2. One of the failure modes presents two causes that lead to the failure mode, in order to better understand these were named F1-C1 and F1-C2, where F1 represents the failure mode 1, and C1 and C2 are the causes 1 and 2 respectively.

Then, according to the criticality matrix, two components are identified as critical, that is the shaft and the wire.

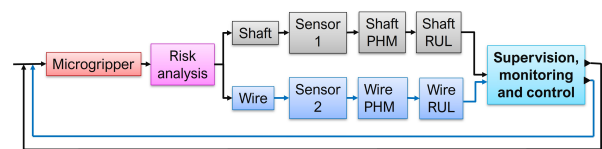

Figure 7. Monitoring of the critical components of the microgripper

The support and the two jaws of the microgripper are joined by the shaft. Serious patient injuries can be caused by the shaft breaking during a surgical procedure. In the same way, something similar happens with wires, whether one of these breaks, the microgripper can no longer perform its functions. Therefore, in both cases, the microgripper will no longer be able to operate.

The importance of selecting them as critical allows to prevent the occurrence of failures during a surgical procedure and to estimate their RUL. In this way, one can define how many hours or how many times the microgripper can operate without failures during a surgical procedure.

5.3. Monitoring of the critical components of the microgripper

Once the critical components of the microgripper are selected, the next step is monitoring through the implementation of sensors that allow data collection on their behavior and performance. The sensor's implementation must be performed strategically in order to get useful information for PHM implementation. Figure 7 includes a block diagram with the steps to follow to PHM implementation in future works, as well as its real-time monitoring.

6. CONCLUSION

The contribution of this work was to develop a methodology in order to select critical components of a microgripper dedicated to intracorporeal surgeries. This selection was realized through a risk analysis based on the requirements of ISO 14971 for medical devices. Likewise, this work shows the importance of selecting the critical components, when analyzing the causes that lead to failure modes from the early design stage in order to develop the PHM at design stage. The proposed methodology can be adapted to analyze the critical components of similar micro medical devices. The root causes which affect the safety and reliability can be exposed thanks to this procedure. This work is the base to develop the PHM system for micro medical devices in future works. Since by knowing the critical components, these can be deeply analyzed through the implementation of sensors.

ACKNOWLEDGMENT

This work has been supported by the EIPHI Graduate school (contract "ANR-17-EURE-0002") and the ANRT-AMAROB CIFRE Thesis.

REFERENCES

Army-GOE. (2006). Failure Modes, Effects and Criticality Analysis (Fmeca) for Command, Control, Communications, Computer, Intelligence , Surveillance, Facilities.

- Basu, S. (2017). Chapter iv - guided word hazard analysis. In S. Basu (Ed.), *Plant hazard analysis and safety instrumentation systems* (p. 201-302). Academic Press.
- Bona, G., Silvestri, A., Forcina, A., & Petrillo, A. (2017, 04). Total efficient risk priority number (terpn): a new method for risk assessment. *Journal of Risk Research*, 21, 1-25.
- Brahimi, M., Medjaher, K., Leouatni, M., & Zerhouni, N. (2016). Critical components selection for a prognostics and health management system design: an application to an overhead contact system..
- Dhillon, B. (2000). *Medical Device Reliability and Associated Areas*. CRC Press.
- Dyadem. (2003). *Guidelines for failure modes and effects analysis for medical devices* (first ed.). CRC Press.
- Elahi, B. (2018). Chapter 12 - risk analysis techniques. In B. Elahi (Ed.), *Safety risk management for medical devices* (p. 67-120). Academic Press.
- Fechter, R., & Barba, J. (2004). Failure mode effect analysis applied to the use of infusion pumps. *The 26th Annual International Conference of the IEEE Engineering in Medicine and Biology Society*, 2, 3496-3499.
- Fernandes, R., & Gracias, D. H. (2009). Toward a miniaturized mechanical surgeon. *Materials Today*, 12(10), 14-20.
- Fu, Y., Luo, J., Flewitt, A., & Milne, W. (2012). 11 - smart microgrippers for biomems applications. In S. Bhansali & A. Vasudev (Eds.), *Mems for biomedical applications* (p. 291-336). Woodhead Publishing.
- Group, O. M. C. (2022). *Olympus 3d/flexdex® for minimal access surgery simplifies suturing, redefines robotics*.
- Holcomb, G. W. (2010). chapter 50 - laparoscopy. In G. W. Holcomb, J. P. Murphy, & D. J. Ostlie (Eds.), *Ashcraft's pediatric surgery (fifth edition)* (Fifth Edition ed.). W.B. Saunders.
- ISO. (2019). *International organization for standardization iso 14971 medical devices — application of risk management to medical devices* (Tech. Rep.). ISO/TC 210 Quality management and corresponding general aspects for medical devices.
- Kiran, D. (2017). Chapter 26 - failure modes and effects analysis. In D. Kiran (Ed.), *Total quality management* (p. 373-389). Butterworth-Heinemann.
- MMI. (2020, oct). *Mmi spa launches breakthrough technology, advancing robotic microsurgery with the world's smallest wristed surgical instruments*.
- Mosallam, A., Medjaher, K., & Zerhouni, N. (2015, 10). Component based data-driven prognostics for complex systems: Methodology and applications..
- Onofrio, R., Piccagli, F., & Segato, F. (2015). Failure mode, effects and criticality analysis (fmeca) for medical devices: Does standardization foster improvements in the practice? *Procedia Manufacturing*, 3, 43-50.
- Ramakrishna, S., Tian, L., Wang, C., Liao, S., & Teo, W. E.

(2015). 5 - risk assessment management for a new medical device. In S. Ramakrishna, L. Tian, C. Wang, S. Liao, & W. E. Teo (Eds.), *Medical devices* (p. 123-135). Woodhead Publishing.

Surgical, F. (2022). *Robotic functionality. minus the robot.*

Tr, I. S. O. (2020). REPORT PROOF / ÉPREUVE Reference number. , 2020.

Valley, C. (2018, oct). *Olympus 3d/flexdex® for minimal access surgery simplifies suturing, redefines robotics.*

Zio, E. (2022). Prognostics and health management (phm): Where are we and where do we (need to) go in theory and practice. *Reliability Engineering & System Safety*, 218, 108119.

BIOGRAPHIES



Liseth Pasaguayo received her Master degree in Mechatronics Engineering from École Nationale Supérieure de Mécanique et des Microtechniques in France, Nile University in Egypt and University of Oviedo in Spain in 2020. She received her degree in Mechatronics Engineering from Tecnica del Norte University in Ecuador in 2017. Currently, she is a doctoral researcher at FEMTO-ST institute and at Amarob Technologies, she is preparing a thesis CIFRE focused on estimating the remaining useful life of a microsystem for intracorporeal surgeries. She is a member of IEEE Reliability Society, and IEEE Women in Engineering Society.



Zeina Al Masry received her PhD. in Applied Mathematics from the University of Pau and Pays de l'Adour in France in 2016. She joined École Nationale Supérieure de Mécanique et des Microtechniques (SUPMICROTECH-

ENSMM) in Besançon, France as an associate professor in 2017. She is doing her research activities at FEMTO-ST institute in the Data Science and Prognostics and Health Management (DATA-PHM) research group. Her research works concern data quality management, applied statistics and stochastic processes in healthcare and industry.



Sergio Lescano is the founder and CEO of Amarob Technologies. Before specializing in entrepreneurship at HEC-Paris, he realized his PhD thesis at FEMTO-ST (CNRS 6174 - UBFC) as part of the European FP7 project RALP, where he worked on the design, fabrication and control of the micro-robot placed in the laryngoscope distal-end, destined to guide a laser beam onto the vocal fold. He is co-inventor of three patents (2 on the microrobot, 1 on a haptic stylus). He has participated in several collaborative projects (FP7 RALP, ANR GreenShield, BPI FrenchTech).



Noureddine Zerhouni received his engineering degree from National Engineers and Technicians School of Algiers (ENITA) in 1985. After a short period in industry as an engineer, he received his Ph.D. Degree in Automatic Control from the Grenoble National Polytechnic Institute in 1991. In September 1991, he joined the National Engineering School of Belfort (ENIB) as Associate Professor. Since 1999, he is Professor of Universities at the École Nationale Supérieure de Mécanique et des Microtechniques (SUPMICROTECH-ENSMM) in Besançon. He is doing his research in the Automatic department of the FEMTO-ST Institute in Besançon. His areas of research are related to the monitoring and maintenance of production systems. He is also an expert in adult education in the areas of process improvement and project management.